

i8 and i8T i6 and i6T i4 and i4T

Installation Loudspeakers

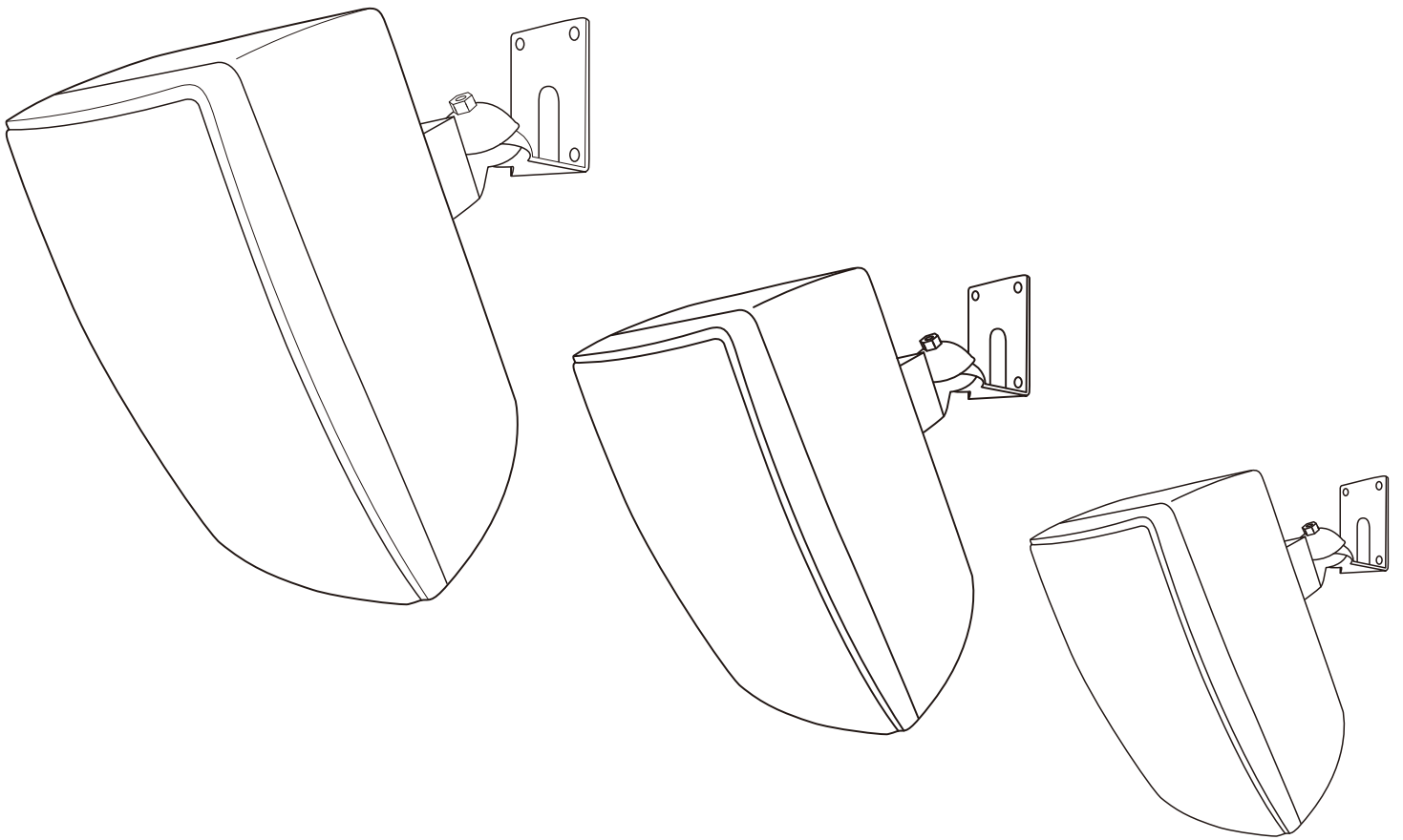

CONTENTS

Warnings	1
Introduction / Features	2
Supplied parts	3
Installation	4
Low impedance and 70v / 100v connections	5-8
KNOB MARKINGS i6T and i8T	9
Specifications	10-12

IMPORTANT WARNINGS & SAFETY INSTRUCTIONS

- Read these instructions
- Follow these instructions
- Keep these instructions for future reference
- Heed all warnings
- Do not use this system near moisture or water
- Clean only with a dry cloth
- Install in accordance with these Wharfedale Pro operating instructions
- Follow the manufacturer's operating instructions for all peripheral devices such as amplifiers and processors
- Do not install near heat sources such as radiators, heat registers, stoves or any other apparatus that produces heat (for example lighting systems and amplifiers)
- Use only accessories specified or supplied by Wharfedale Pro
- Do not use shielded microphone/instrument cables to connect amplifiers and speakers, use only approved speaker cables with proper connectors
- Use caution with placement and operation of this speaker system, permanent hearing damage can be caused by prolonged exposure to excessive sound pressure levels
- Refer all servicing to qualified professionals. Servicing is required when the loudspeaker has been damaged in any way, such as impact damage, liquid ingress or foreign object damage. In addition the loudspeaker should be referred to qualified service personnel if there is any kind of malfunction.



- Rigging, suspending and mounting should only be attempted by experience qualified professionals. Incorrect usage can result in damage to equipment and property, injury and even death. Under no circumstances should you attempt to rig, suspend or mount these speakers unless you are fully qualified and certified to do so by relevant local, state and national authorities. If you are not properly qualified or do not know of pertinent regulations consult qualified personnel for advice. Consult a structural engineer before suspending a speaker system and ensure that the total weight of your system can be held by the truss or mounting surface.



- Inspect all mounting hardware before rigging, suspending or mounting. If there is any damage or distortion to any mounting hardware do not proceed until any damaged hardware is repaired or replaced.

INTRODUCTION

The i series are two-way high performance speaker systems designed for distributed music, paging and speech applications.

Each model features a quality low frequency transducer and a 1" dome tweeter housed in a durable ABS enclosure with a full protective frontal grille. All i series speakers are also supplied with a sturdy wall mounting bracket.

i8, i6 and i4 are low-impedance 8Ω models and i8T, i6T and i4T feature internal transformers for use with 70/100V installations.

i8 / i6

Black or white, 8 Ohms, 50 Watts RMS

i4

Black or white, 8 Ohms, 25 Watts RMS

i8T / i6T

Black or white, 50 Watts RMS, 70/100 Volt transformer included.

i4T

Black or white, 25 Watts RMS, 70/100 Volt transformer included.

PRODUCT FEATURES

The i series are fitted with 4 threaded inserts on the rear for attaching the supplied mounting bracket. Access to the mounting points is gained by removing the four screws and the blank cover plate. There is also a threaded insert for attachment of a seismic restraint tether.

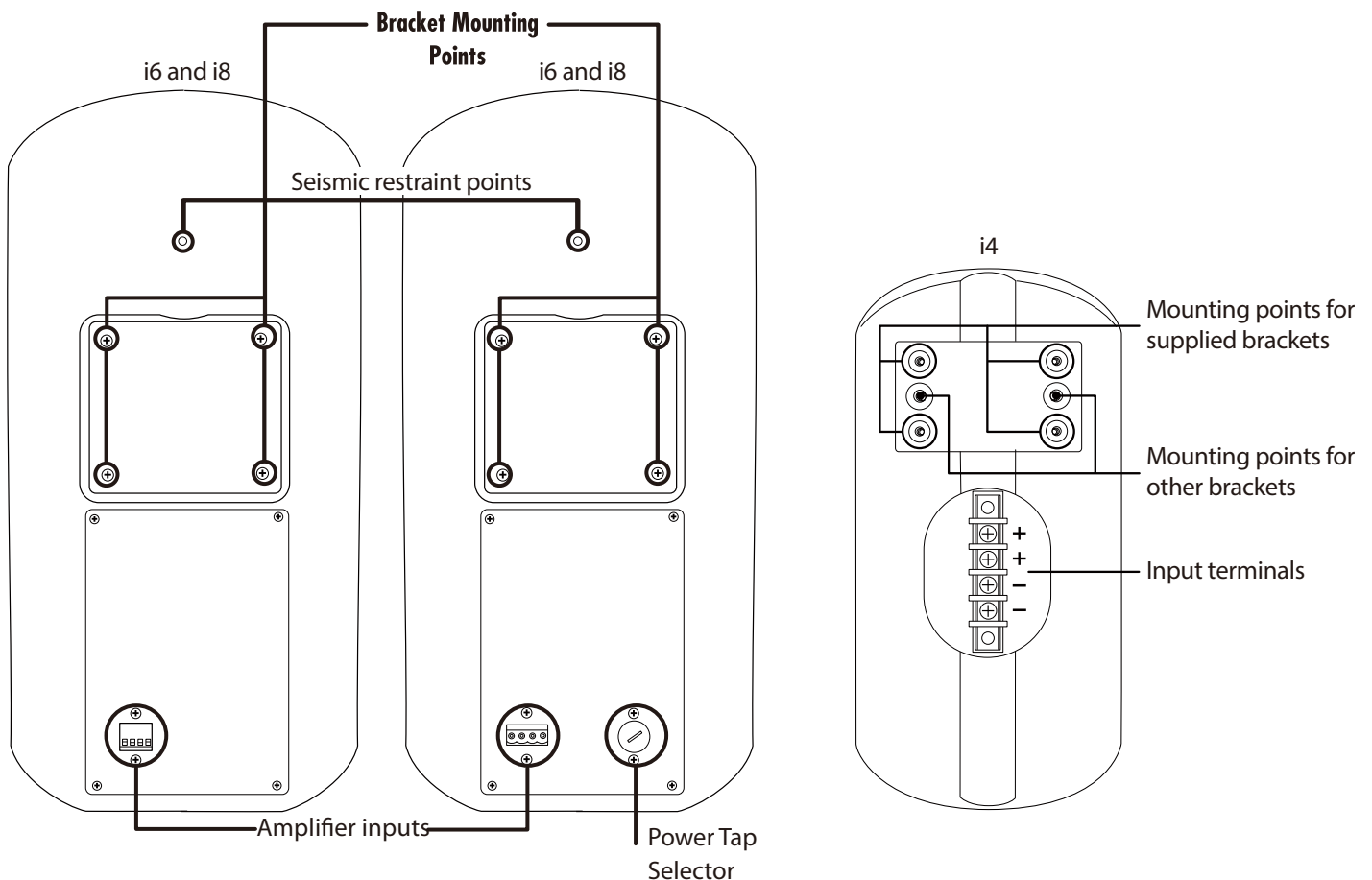

SUPPLIED PARTS

A complete installation kit designed to work with the mounting brackets is included with each model and consists of...

- 1 - Seismic restraint tethers (2 pcs)
- 2 - Bracket mounting screws (8 pcs)
- 3 - Lock washers (2 pcs)
- 4 - Nylon locking nuts (2 pcs)
- 5 - Friction pads (2 pcs)
- 6 - Adhesively attached rubber feet (2 pcs)

Please ensure that you are familiar with all of the parts and how they are assembled before commencing the installation.

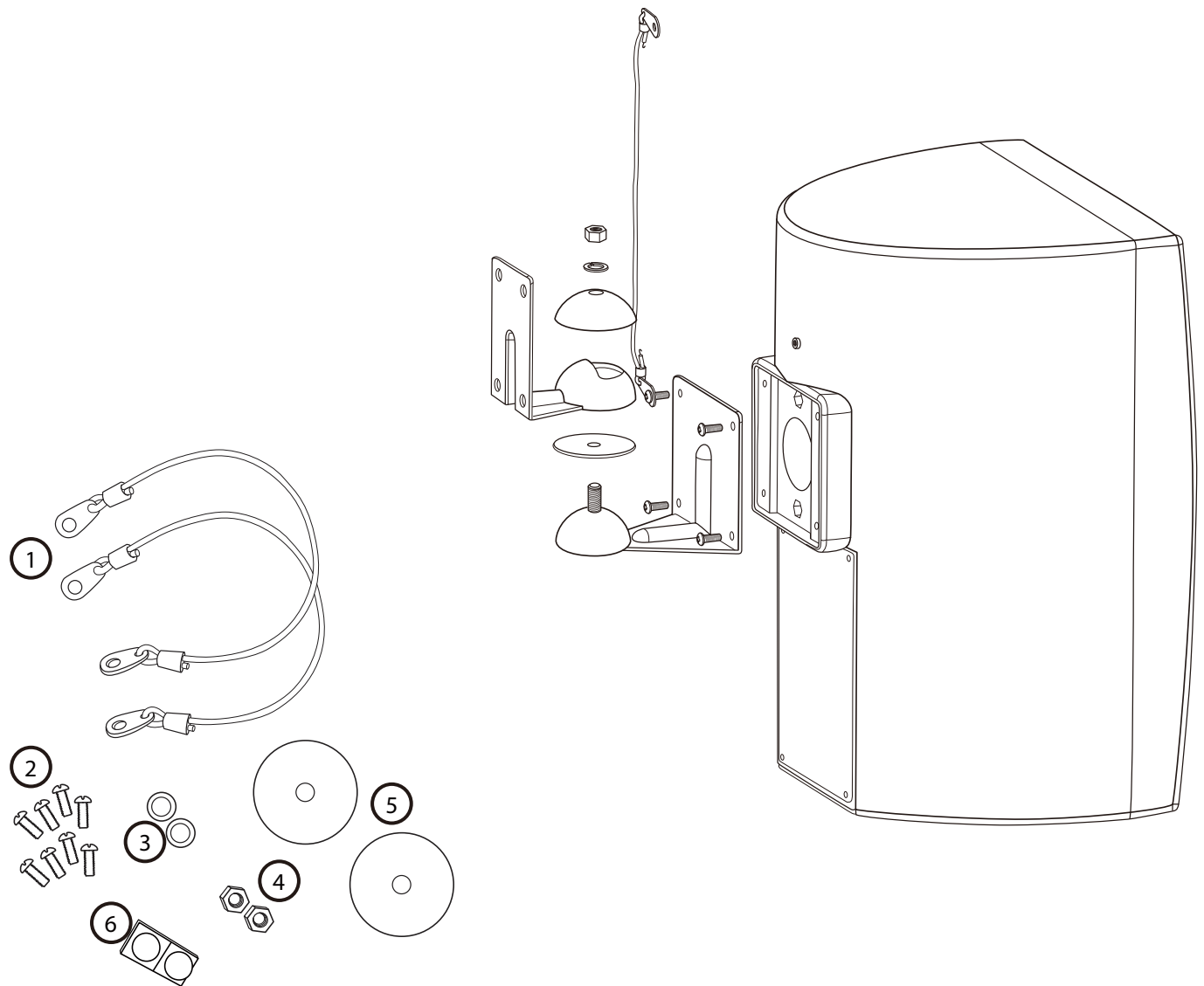

INSTALLATION

STEP 1 - Install bracket to wall using suitable fasteners

STEP 1a - Remove the four screws holding the cover plate (2) on the rear of the speaker.

STEP 1b - Mount the bracket with the threaded bolt to the cabinet using the four screws removed in step 1 (4)

STEP 2 - Place the rubber friction washer over the bolt.

STEP 3 - When the speaker is ready for installation, insert the bolt in the wall plate bracket from below.

STEP 4 - Place the dome cover over the bolt

STEP 5 - Place the lock washer and hex nut on the bolt. Tighten gently while positioning the speaker as required. Then tighten firmly.

STEP 6 - Ensure that the seismic restraint cable is firmly attached to both the loudspeaker and an anchor point on the mounting surface.

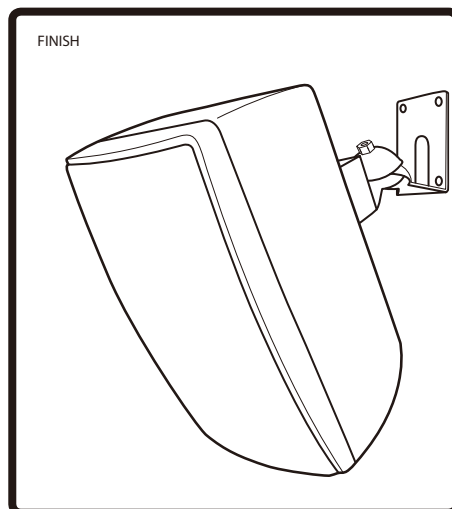
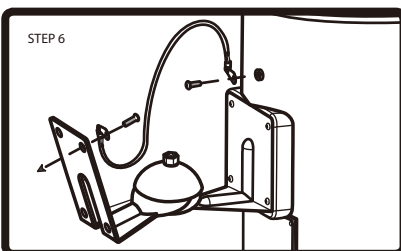
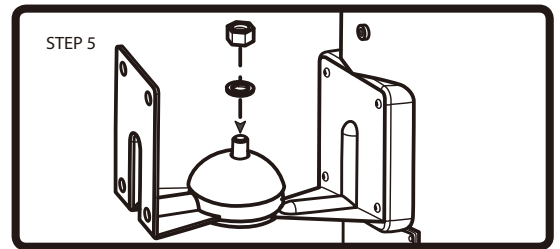
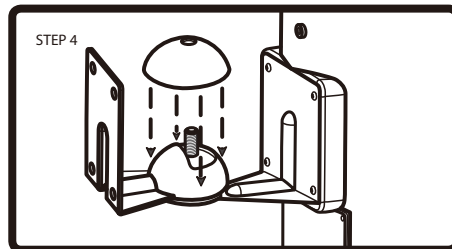
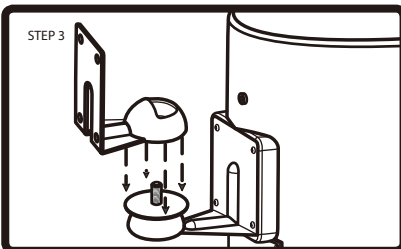
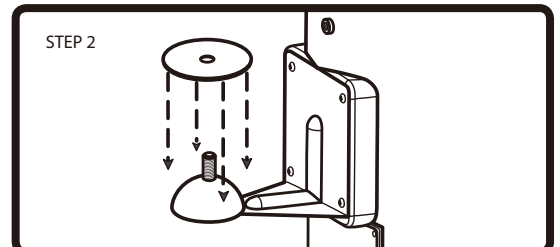
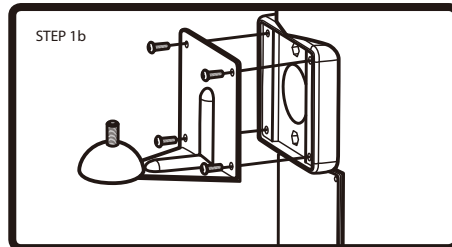
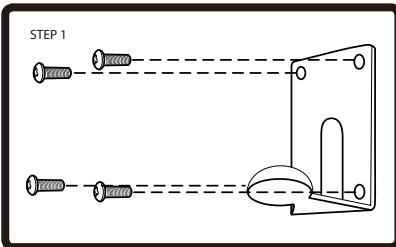

LOW IMPEDANCE (8Ω) CONNECTIONS (i8, i6 and i4 models)

The i8, i6 and i4 are fitted with two terminals for the (+) and (-) incoming amplifier feed and two terminals for connection to the next speaker if used.

Speakers should be wired in parallel as per the table below. Ensure that the total impedance of connected speakers does not fall below the minimum impedance of the connected amplifier. The following table shows the net impedance when several speakers are combined in parallel.

Number of Speakers in Parallel Combined Impedance

1	8Ω
2	4Ω
3	2.6Ω
4	2Ω

70 / 100v CONNECTIONS (i8T and i6T models)

The i8T and i6T are fitted with two terminals for the (+) and (-) incoming amplifier feed and two terminals for connection to the next speaker if used.

Speakers should be wired in parallel as shown below. Wattage taps to each individual speaker are set by means of the rotary selector switch. Ensure that the total wattage required by all speakers does not exceed the available wattage of the connected amplifier.

CAUTION : Note that the wattage taps are labelled for 70v and 100v amplifiers. Ensure that you select the correct tap based on the connected amplifier.

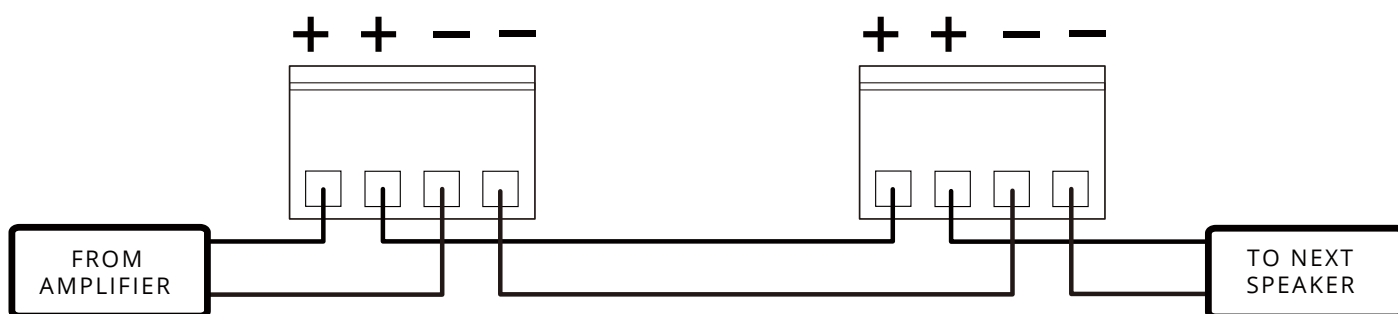

Select the wattage tap by dividing the amplifier's maximum available power by the number of speakers to be connected. Always select the next lower wattage tap. For example...

200w amplifier / 20 speakers = 10 watts. Use the 7.5w terminal.

Individual speakers may be tapped higher or lower in order to better balance the system sound pressure level in different areas. Ensure that the combined power draw does not exceed the maximum rated power of the amplifier or damage to the amplifier and speakers could occur.

i4 Low impedance (8Ω) connections

Low impedance models are fitted with two terminals for the (+) and (-) incoming amplifier feed and two terminals paralleled to the next speaker.

Speakers may be wired in parallel as shown below. Ensure that the total impedance of connected speakers does not fall below the minimum impedance of the connected amplifier. The following table shows the net impedance when several speakers are combined in parallel.

Number of Speakers in Parallel Combined Impedance

1	8Ω
2	4Ω
3	2.6Ω
4	2Ω

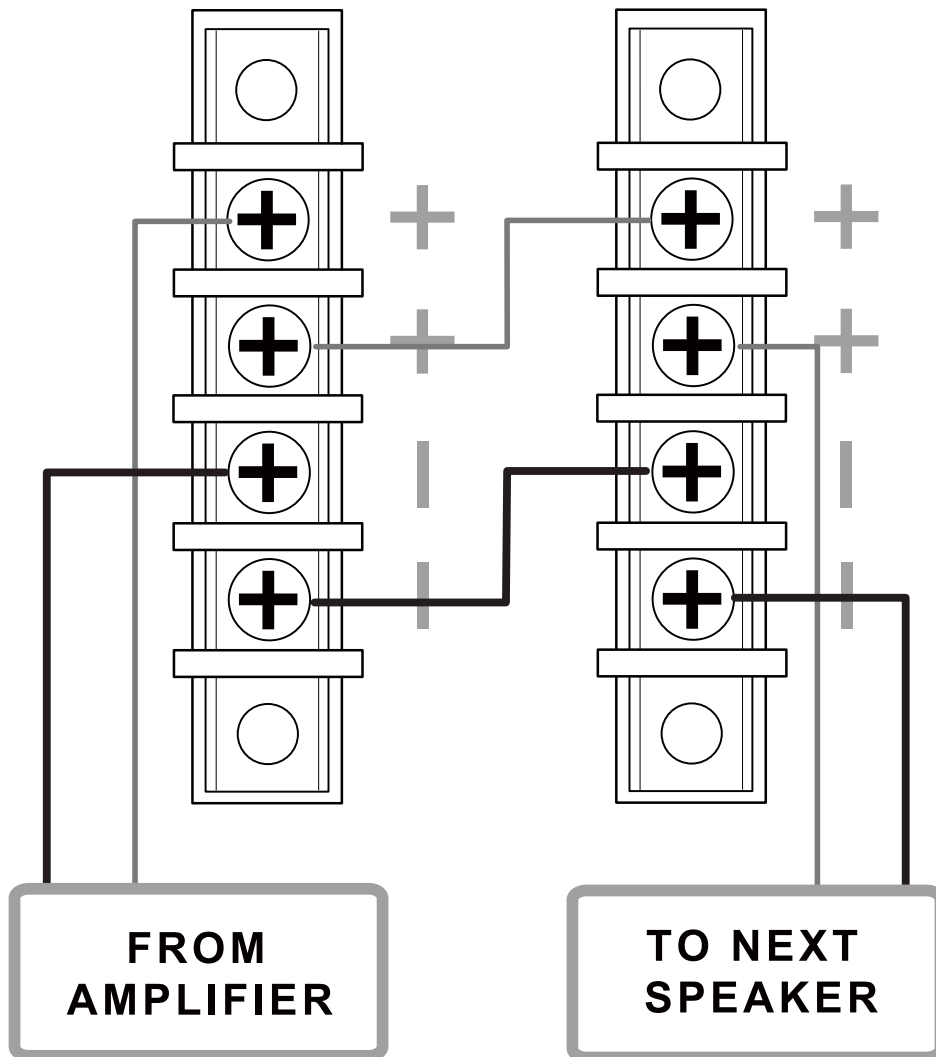

70 / 100V CONNECTIONS - i4T

The 70/100V i4T model uses one terminal for the Common (-) connection and the other three terminals for the transformer power taps. The i4T offers taps at 25W/12.5W/6.25W

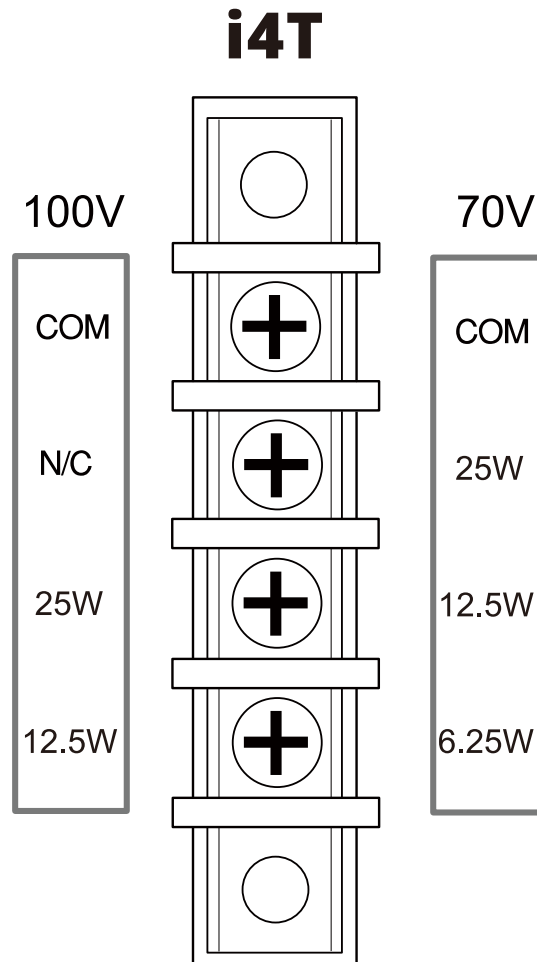

NOTE:

Power taps are labeled for 70V operation. Connection of 100V amplifiers requires use of the next lower wattage tap to prevent damage to the speaker. See chart below.

Model : i4T			
Tap Label	70V	100V	Impedance Ω
25W	25W	N/C	200
12.5W	12.5W	25W	400
6.25W	6.25W	12.5W	800

Connect speakers in parallel as shown below:

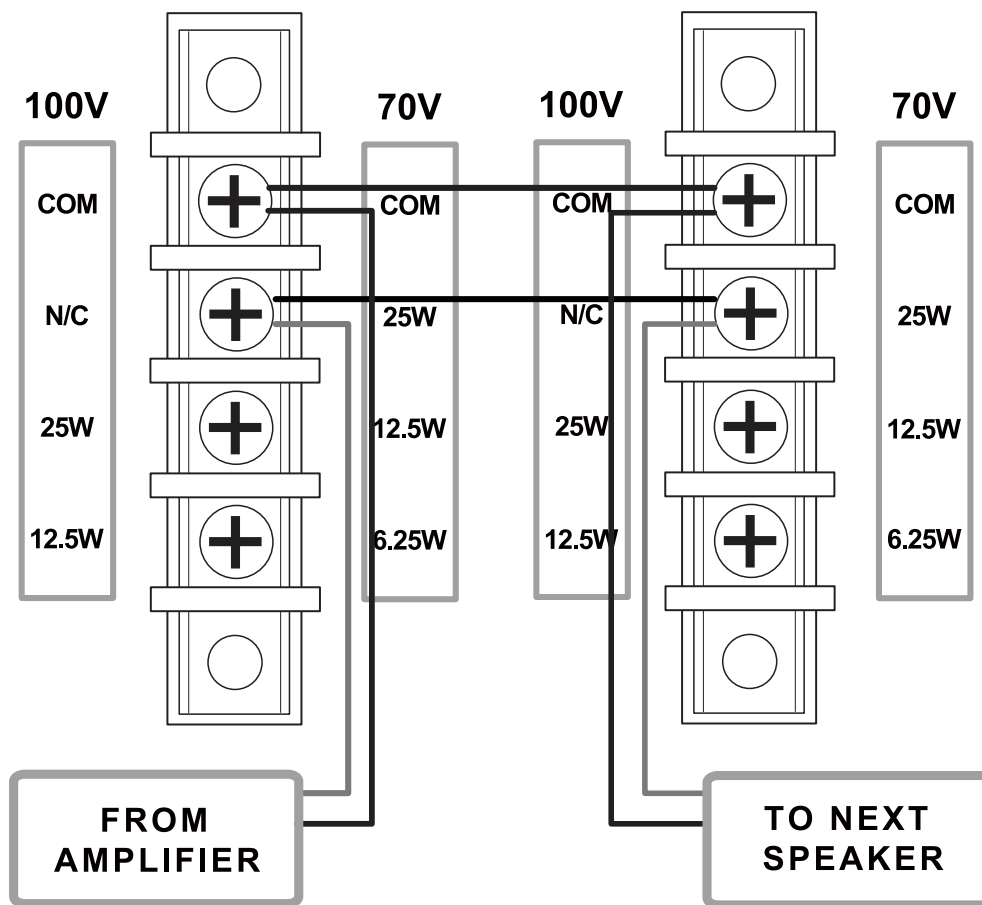

Select the power tap by dividing the amplifier's available power by the number of speakers to be connected and then selecting the next lower wattage tap. For example:

200W amplifier ÷ 20 speakers = 10 Watts; use the 7.5W terminal

Individual speakers may be tapped higher or lower in order to better balance the system sound pressure level in different areas. Ensure that the combined power draw does not exceed the maximum rated power of the amplifier or damage to the amplifier and speakers could occur.

KNOB MARKINGS i6T and i8T

Take note of the black arrows on both side of the knob.
When the black arrows on both sides point to OFF, the speaker is OFF.

When the arrow points to the red dot, there is no connection to the 100v tap. The connection is made at 50w (70v).

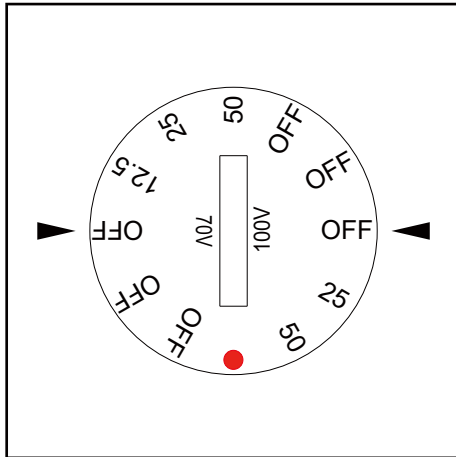

50w on 100v
and
25w on 70v

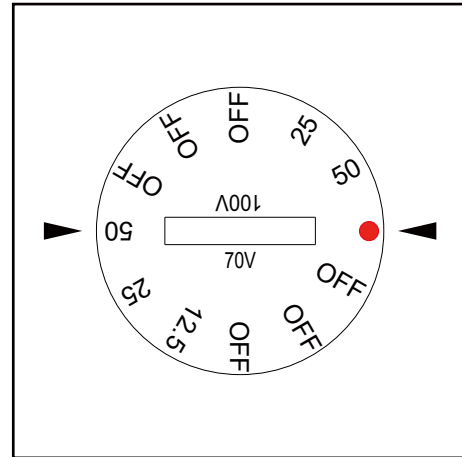

25w on 100v
and
12.5w on 70v

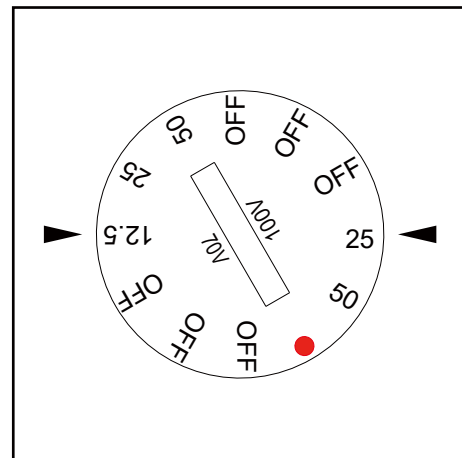
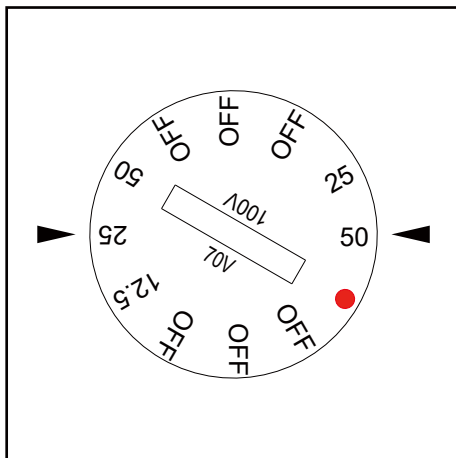

100V Line:

●
50w
25w

70v Line:

50w
25w
12.5w

SPECIFICATIONS

Model Name	i8	i8T
System Type	Passive	Passive
Configuration	Two-way	Two-way
Frequency Response (+/-3dB)	70Hz - 20kHz	70Hz - 20kHz
Frequency Range (-10dB)	50Hz - 20kHz	50Hz - 20kHz
Sensitivity (2.83v/1m)	87dB	86dB
Calculated Maximum SPL @1m	110dB	103dB
System Rated Impedance	8Ω	n/a
Low Frequency Transducer		
Size	8"	8"
Voice Coil Size	1"	1"
Rated Impedance	8Ω	8Ω
LF Power (re:AES2-2012)	50W	50W
High Frequency Transducer		
HF Driver Type	Soft dome tweeter	Soft dome tweeter
Voice Coil Size	1"	1"
Diaphragm Material	Silk	Silk
Rated Impedance	8Ω	8Ω
HF Power (re:AES2-2012)	10W	10W
Nominal Coverage (H x V)	130° x 180°	130° x 180°
Power		
System Continuous Power	50w	70v : 12.5w /25w / 50w
System Programme Power	100w	100v : 25w / 50w
System Peak Power	200w	
Crossover frequency	2.0kHz	2.0kHz
Input Connector	Phoenix terminal	Phoenix terminal
Hardware	Wall mount bracket included	Wall mount bracket included
Enclosure		
Enclosure Material and finish	Plastic (ABS)	Plastic (ABS)
Colour Options	Black or White	Black or White
Grille Material & Finish	Aluminium	Aluminium
Dimensions - Unpacked		
Height	405mm / 15.8"	405mm / 15.8"
Width	270mm / 10.6"	270mm / 10.6"
Depth	234mm / 9.2"	234mm / 9.2"
Dimensions - Packed(1 PAIR)		
Height	549mm / 21.6"	549mm / 21.6"
Width	602mm / 23.7"	602mm / 23.7"
Depth	363mm / 14.3"	363mm / 14.3"
Weight		
Net Weight (single speaker)	4.7kg / 10.34lbs	5.7kg / 12.54lbs
Gross Weight (1PAIR,Include Bracket)	12.7kg / 27.9lbs	14.7kg / 32.34lbs

SPECIFICATIONS

Model Name	i6	i6T
System Type	Passive	Passive
Configuration	Two-way	Two-way
Frequency Response (+/-3dB)	70Hz - 20kHz	70Hz - 20kHz
Frequency Range (-10dB)	50Hz - 20kHz	50Hz - 20kHz
Sensitivity (2.83v/1m)	86dB	85dB
Calculated Maximum SPL @1m	109dB	102dB
System Rated Impedance	8Ω	n/a
Low Frequency Transducer		
Size	6.5"	6.5"
Voice Coil Size	1"	1"
Rated Impedance	8Ω	8Ω
LF Power (re:AES2-2012)	50w	50w
High Frequency Transducer		
HF Driver Type	Soft dome tweeter	Soft dome tweeter
Voice Coil Size	1"	1"
Diaphragm Material	Silk	Silk
Rated Impedance	8Ω	8Ω
HF Power (re:AES2-2012)	10W	10W
Nominal Coverage (H x V)	150° x 170°	150° x 170°
Power		
System Continuous Power	50w	70v : 12.5w / 25w / 50w
System Programme Power	100w	100v : 25w / 50w
System Peak Power	200w	
Crossover frequency	2.2kHz	2.2kHz
Input Connector	Phoenix terminal	Phoenix terminal
Hardware	Wall mount bracket included	Wall mount bracket included
Enclosure		
Enclosure Material and finish	Plastic (ABS)	Plastic (ABS)
Colour Options	Black or White	Black or White
Grille Material & Finish	Aluminium	Aluminium
Dimensions - Unpacked		
Height	370mm / 14.6"	370mm / 14.6"
Width	245mm / 9.6"	245mm / 9.6"
Depth	216mm / 8.5"	216mm / 8.5"
Dimensions - Packed(1 PAIR)		
Height	495mm / 19.5"	495mm / 19.5"
Width	565mm / 22.3"	565mm / 22.3"
Depth	340mm / 13.4"	340mm / 13.4"
Weight		
Net Weight (single speaker)	4.30kg / 9.46lbs	5.3kg / 11.6lbs
Gross Weight (1PAIR,Include Bracket)	11.12kg / 24.5lbs	13.75kg / 30.25lbs

SPECIFICATIONS

Model Name	i4	i4T
System Type	Passive	Passive
Configuration	Two-way	Two-way
Frequency Response (+/-3dB)	100Hz - 20kHz	100Hz - 20kHz
Frequency Range (-10dB)	60Hz - 20kHz	60Hz - 20kHz
Sensitivity (2.83v/1m)	84dB	83dB
Calculated Maximum SPL @1m	105dB	95dB
System Rated Impedance	8Ω	n/a
Low Frequency Transducer		
Size	4"	4"
Voice Coil Size	1"	1"
Rated Impedance	8Ω	8Ω
LF Power (re:AES2-2012)	25W	25W
High Frequency Transducer		
HF Driver Type	Soft dome tweeter	Soft dome tweeter
Voice Coil Size	1"	1"
Diaphragm Material	Silk	Silk
Rated Impedance	8Ω	8Ω
HF Power (re:AES2-2012)	10W	10W
Nominal Coverage (H x V)	110° x 130°	110° x 130°
Power		
System Continuous Power	25w	70v : 6.25w / 12.5w / 25w
System Programme Power	50w	100v : 12.5w / 25w
System Peak Power	100w	
Crossover frequency	2.8kHz	2.8kHz
Input Connector	Screw terminal	Screw terminal
Hardware	Wall mount bracket included	Wall mount bracket included
Enclosure		
Enclosure Material and finish	Plastic (ABS)	Plastic (ABS)
Colour Options	Black or White	Black or White
Grille Material & Finish	Aluminium	Aluminium
Dimensions - Unpacked		
Height	232mm / 9.1"	232mm / 9.1"
Width	160mm / 6.3"	160mm / 6.3"
Depth	148mm / 5.8"	148mm / 5.8"
Dimensions - Packed(1 PAIR)		
Height	335mm / 13.2"	335mm / 13.2"
Width	425mm / 16.7"	425mm / 16.7"
Depth	210mm / 8.3"	210mm / 8.3"
Weight		
Net Weight (single speaker)	2.1kg / 4.62lbs	2.72kg / 5.98lbs
Gross Weight (1PAIR,Include Bracket)	5.86kg / 12.9lbs	7.1kg / 15.6lbs

WHARFEDALE PRO LIMITED WARRANTY

Wharfedale Pro products are warranted of manufacturing or material defects for a period of one year from the original date of purchase. In the event of malfunction, contact your authorised Wharfedale Pro dealer or distributor for information.

*Be aware that warranty details may differ from country to country. Contact your dealer or distributor for information. These terms do not infringe your statutory rights.



Wharfedale Professional
IAG House 13/14 Glebe Road Huntingdon Cambridgeshire PE29 7DL UK
www.wharfedalepro.com

Wharfedale Professional reserves the right to alter or improve specifications without notice.
All rights reserved © 2020 Wharfedale Pro. Wharfedale Pro is a member of the IAG Group.